

RVW Series

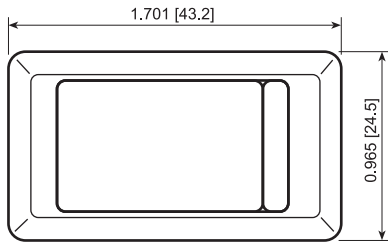

Panel Cutout

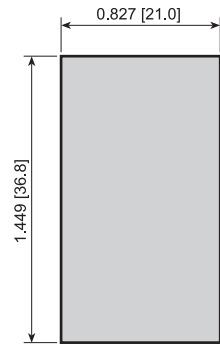

Terminal Options

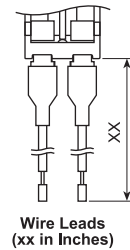
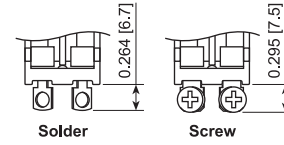
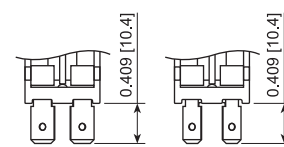

FEATURES:

- Heavy Duty Ratings with cULus Approval
- Full Size Rocker Switch
- Internal Dust and Water Protection to IP54
- Glossy Finish Option

SPECIFICATIONS:

- RATING:** MAINTAINED SWITCHES:
 20A 125VAC [cULus UL508]
 15A 277VAC [cULus UL508]
 2HP 125-250VAC [cULus UL508]
- MOMENTARY SWITCHES:
 20A 125VAC [cULus UL508]
 15A 277VAC [cULus UL508]
 1.5HP 125-250VAC [cULus UL508]

- TEMPERATURE: -20°C to 55°C
 ELECTRICAL LIFE: 6,000 Cycles [cULus]
 CONTACT RESISTANCE: 50mΩ Max.
 INSULATION RESISTANCE: 800MΩ Min. at 500VDC
 DIELECTRIC STRENGTH: 1,500VAC for 1 Minute
 INGRESS PROTECTION: IP54 Standard

MATERIALS:

- Body: Polyamide 6/6, UL94 V-2
 ACTUATOR: Polyamide 6/6, UL94 V-2
 CONTACTS: Silver Alloy
 TERMINALS: Brass
 Silver Plated Brass

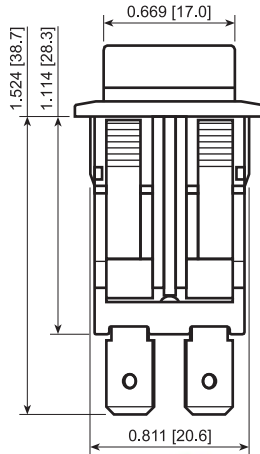
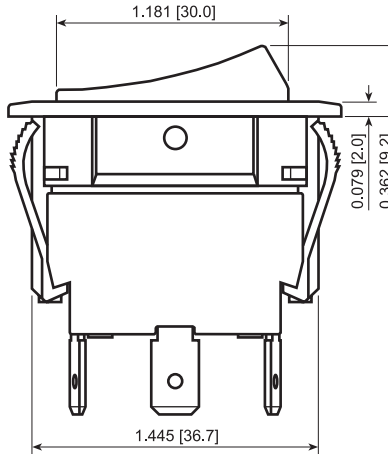

RVW52D1100



RVW42D2223

RVW46D1122

RVWW6Z02D1100

SPECIFICATIONS SUBJECT TO CHANGE WITHOUT NOTICE

Series	Terminal	Function	Rating	Body Color	Actuator Color	Marking Color	Marking Type
<input type="checkbox"/> RVW - Matte Finish <input type="checkbox"/> RVWG - Glossy Finish	<input type="checkbox"/> 1 - 4.8mm Tabs <input type="checkbox"/> 4 - 6.3mm Tabs <input type="checkbox"/> 5 - Solder <input type="checkbox"/> 6 - Screw Variable Length: Wxx - Wire Leads	1 Pole: 1 - Off-On 3 - On-On 4 - Off-(On) 5 - On-Off-On A - On-(Off) B - On-(On) C - On-Off-(On) D - (On)-Off-(On) 2 Pole: 2 - Off-On G - On-On E - Off-(On) 6 - On-Off-On F - On-(Off) H - On-(On) J - On-Off-(On) K - (On)-Off-(On)	D - 20A 125VAC	1 - Black 2 - White 3 - Almond 4 - Grey 5 - Orange 7 - Blue 8 - Green 9 - Red	1 - Black 2 - White 3 - Almond 4 - Grey 5 - Orange 7 - Blue 8 - Green 9 - Red	0 - None 1 - Black 2 - White 8 - Red	0 - None 1 - I/O Vert. 2 - ON/OFF/ON Vert. 3 - ON/OFF Vert. 4 - ON/OFF Horiz. 9 - I/O/II Horiz. S - I/O/II Vert. R - I/O Horiz.

Custom Colors and Markings Available Upon Request

EXAMPLE PART NUMBERS:

- RVW41D1100 1P Off-On
 Black Body/Actuator, No Marking
- RVW42D1100 2P Off-On
 Black Body/Actuator, No Marking
- RVW42D1121 2P Off-On
 Black Body/Actuator, I/O Vert.
- RVW43D1100 1P On-On
 Black Body/Actuator, No Marking
- RVW45D1100 1P On-Off-On
 Black Body/Actuator, No Marking
- RVW46D1100 2P On-Off-On
 Black Body/Actuator, No Marking
- RVW4GD1100 2P On-On
 Black Body/Actuator, No Marking
- RVWG41D1100 1P Off-On
 Glossy, Black Body/Actuator, No Marking
- RVWG42D1100 2P Off-On
 Glossy Black Body/Actuator, No Marking

